



Through The Lych Gate of Saint Francis Church



December 2007

The other day Phil and I went to Pier I in Spartanburg and the girl in the store greeted us with "Happy Holidays!" As I walked away, I chuckled for all the talk about what is 'politically correct' to say. Some businesses are concerned about wishing a person "Merry Christmas" for one might be offended and may not patronize their store. Don't they know?

The word "Christmas" is a shortened form of the two words, "Christ Mass." This describes the first church service on Christmas Day.

The words "Happy Holidays" are the shortened form of the phrase "holy day." One is left with the need to explain exactly what holy day we are celebrating and what makes it holy!

Even the words, "Season's Greetings" leave us questioning what season and why do we wish others well because of it?"

Evergreens have traditionally been used because the triangular shape reminds us of the Holy Trinity. Evergreens do not drop their foliage, a symbol of eternal life, a promise of God through our Lord Jesus.

Wreaths are shaped in a circle with no beginning and no end which is another symbol of eternity.

Lights on the tree remind us that Jesus is the Light of the World.

The star or angel on top of the tree reminds us that both were present in the night sky on the eve

that Jesus was born. A star led the Wise Men to Jesus' birthplace.

During the Middle Ages in Germany, there was a play called "The Paradise Tree" about the creation of the world and was performed on December 24th. Apples were fastened on evergreen trees but the weight of the apples brought the branches down. A German glass blower discovered he could create lightweight ball-shaped ornaments from glass. He made them in the shape of the world so that they would remind people that God was the Creator of the world.

Wafers were hung of the trees as decorations and to remind people of Holy Communion.

So don't even consider taking the Christ out of Christmas because now YOU know!

You will find the schedule of the Christmas services in this issue of the Lychgate. If you are unable to attend any of the services, please let me know so that we may arrange to have the Holy Communion brought to you. When I was confirmed in the Episcopal Church all persons were required to receive Communion at the Principal High Feasts, which of course includes Christmas. The church no longer makes that requirement; it is left to you and God. How can you not celebrate the most incredible miracle of love on earth!

Let us celebrate the wonder of the Christ Child together this

Christmas by kneeling and praising Him. My prayer for each of you is a prayerful and peaceful Christmas. I leave you with this cute poem:

T'was The Night Before Christmas Not a Sign of Baby Jesus

*T'was the night before Christmas
and all through the town
Not a sign of Baby Jesus
was anywhere to be found.*

*The people were all busy
with Christmas time chores
Like decorating, and baking,
and shopping in stores.*

*No one sang "Away in a manger,
no crib for a bed".
Instead, they sang of Santa
dressed-up in bright red.*

*Mama watched Martha Stewart,
Papa drank beer from a tap.*

*As hour upon hour
the presents they'd wrap.*

*When what from the TV
did they suddenly hear?
'Cept an ad which told
of a big sale at Sears.*

*So away to the mall
they all flew like a flash
Buying things on credit
and others with cash!*

*And, as they made their way home
From their trip to the mall,
Did they think about Jesus?
Oh, no... not at all.*

Stewardship of Presence

	8am	11am	6pm	Combined
Nov. 4	25	96	9	130
Nov. 11	38	88		126
Nov. 18	36	94		130
Nov. 25	38	79		117

Stewardship of Giving

103 items of food for Yokefellow
Thanksgiving Community Service Offering
For Yokefellow & St. Gabriel's Soup Kitchen
(\$335.50 each)

Stewardship of Giving

	Pledged	Non-Pledged
Nov. 4	\$1,260.75	\$1,677.00
Nov. 11	\$2,158.00	\$842.00
Nov. 18	\$2,505.00	\$954.00
Nov. 25	\$799.22	\$842.00

YOKEFELLOW

Service Center, Inc.
102 Blanton Street ~ Spindale, NC

For December
CANNED MEATS

*(Although any non-perishable
item will be accepted)*



AND HE
GAVE HIM
THE NAME
JESUS.

MATTHEW 1:25, NIV

Holiday Schedule

DOK ADVENT RETREAT

Saturday, December 1
9:00 am ~ Parish House

ADVENT WORKSHOP

Sunday, December 2
7:00 pm ~ Parish House

ANGEL TREE PARTY

Saturday, December 15
6:00 pm ~ Parish House

CHURCH-WIDE CHRISTMAS CAROLING

Sunday, December 16
12:30 pm

VESTRY/STAFF CHRISTMAS PARTY

Sunday, December 16
6:00 pm ~ Rectory

DAYSCHOOL CHRISTMAS PROGRAM/OPEN HOUSE

Thursday, December 20
7:00 pm ~ Sanctuary/Parish House

LESSONS AND CAROLS SERVICE

Sunday, December 23
11:00 am ~ Sanctuary

CHRISTMAS EVE SERVICES

Monday, December 24
5:30 pm ~ Family Service/Holy Communion - Sanctuary
Featuring guest violinist, Dorothy Kunkel
10:30 pm ~ Carols
11:00 pm Choral Eucharist/Holy Communion
Featuring guest harpist,
Deborah Brinson
Sanctuary

CHRISTMAS DAY SERVICE

Tuesday, December 25
10:00 am ~ Sanctuary

NEW YEAR'S EVE SERVICE

Monday, December 31
11:30 pm ~ Sanctuary
Followed by reception at the Rectory

FROM THE RECTOR

...Continued

*Their lives were so busy
with their Christmas time things
No time to remember
Christ Jesus, the King.*

*There were presents to wrap
and cookies to bake.
How could they stop and remember
who died for their sake?*

*To pray to the Savior
they had no time to stop.
Because they needed more time
to "Shop til they dropped!"*

*On Wal-mart! On Big Lots!
On Lowes! On Penney's!
On Hallmark! On Belks!
A quick lunch at Denny's.*

*From the little stores downtown
to the stores at the mall
They would dash away, dash away,
and visit them all!*

*And up on the roof,
there arose such a clatter
As grandpa hung icicle lights
up on his brand new step ladder.*

*He hung lights that would flash.
He hung lights that would twirl.
Yet, he never once prayed to Jesus...
Light of the World.*

*Christ's eyes... how they twinkle!
Christ's Spirit... how merry!
Christ's love... how enormous!
All our burdens... He'll carry!*

*So instead of being busy,
overworked, and uptight
Let's put Christ back in
Christmas and enjoy
some good nights!*

Author Unknown

In Christ's love and wonder,

Dee+

The Rev. Dee Ann deMontmollin+
p.s. Merry Christmas friends!

FROM THE YOUTH DIRECTOR

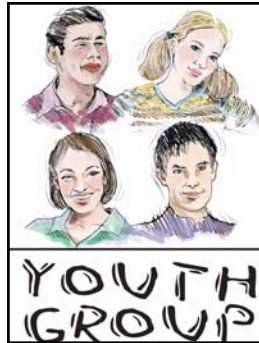

This month has been a busy "planning" month, anticipating the ever-present and quickly approaching holiday season. The Middle School class has begun a new curriculum from David Lynn's Talksheets—50 Creative Discussions for High School Youth Groups. I chose the High School studies for my

Middle Schoolers because the issues are the same and, let's face it, our Youth group is a pretty smart bunch! This has been a success with the group - it gets them actually speaking their minds and getting into deep discussions about issues present today; from prayer, war, relationships, parents, temptation, drug abuse, peer pressure, to many more real life topics. Bible verses are the closing - all relating to the discussion of the day. We talked about what we are all truly thankful for in our lives for Thanksgiving and many answers were surprising! Ask your youth what they are truly thankful for this season and you will get some very adult answers. We have continued with our Jesse Tree ornaments and all are very excited about Christmas just around the corner! We are going to be wrapping presents for donations in December during our Movie Night. The money raised will go to those in need in our community through gifts purchased by our youth—details to follow. What an exciting time of the year for the children of the church! Let's all remember to do our part to reinforce why we are really celebrating this holiday season.

Director to the best youth around,

Amberleigh

Amberleigh Richardson
Youth Director



LECTIONARY READINGS FOR DECEMBER

Dec. 2	First Sunday of Advent	Psalm 122	Isaiah 2:1-5	Romans 13:8-14	Matthew 24:37-44
Dec. 9	Second Sunday of Advent	Psalm 72	Isaiah 11:1-10	Romans 15:4-13	Matthew 3:1-12
Dec. 16	Third Sunday of Advent	Psalm 146	Isaiah 35:1-10	James 5:7-10	Matthew 11:2-11
Dec. 23	Fourth Sunday of Advent	Psalm 80:1-7, 16-18	Isaiah 7:10-16	Romans 1:1-7	Matthew 1:18-25
Dec. 30	First Sunday after Christmas	Psalm 147	Isaiah 61:10-62:3	Galatians 3:23-25; 4:4-7	John 1:1-18

Holy Listening:

Becoming Aware of the Presence of God

An Advent Retreat

An opportunity to open ourselves (mind, body and spirit) to the Presence of God. Learn how to use all our senses to become closer to God in all things of life.

This retreat will take the form of presentations, meditations and silence. An indoor labyrinth will be available for meditation time. The retreat will end with Eucharist.

Saturday, December 1, 2007

9:00 am to 3:00 pm

St. Francis Episcopal Church

Cost is \$15 (includes lunch)

Please call the church office
287-3888 or email the church
stfrancis@rfci.net
by November 26 to register

*Sponsored by the Phoebe Chapter,
Daughters of The King*

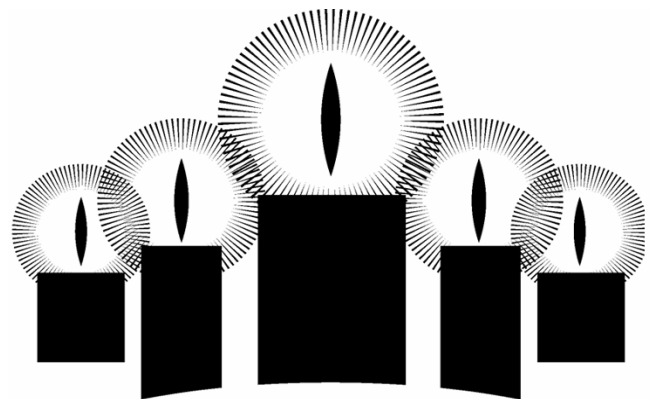

Advent

HOLY LISTENING RETREAT

December 2007

Sunday	Monday	Tuesday	Wednesday	Thursday	Friday	Saturday
<p align="center">Church Potluck: 2nd - Linda Bailey, Bill Coxe and Susan Keith</p> <p align="center">8:00 am Coffee Fellowship: 2nd - Vicki Dury</p> <p align="center">11:00 am Coffee Fellowship: 16 - Jesse & Beverly McKinney</p>						<p align="center">1</p> <p>9:00 AM DOK Advent Retreat</p>
<p align="center">2</p> <p>8:00 AM HE Rite I 8:00 AM Coffee 11:00 AM HE Rite II 12:30 PM Potluck Lunch 5:00 PM Cursillo 6:00 PM Cont. Eucharist 7:00 PM Advent Workshop <i>First Sunday of Advent</i></p>	<p align="center">3</p> <p>5:30 PM Girl Scouts</p>	<p align="center">4</p> <p>7:00 AM Women's Prayer Breakfast @ Carolina Cafe 5:30 PM Handchimes 6:30 PM Adult Choir</p>	<p align="center">5</p> <p>7:00 AM Morning Prayer 10:00 AM HE Healing Service 5:15 PM Joyful Noyz 6:00 PM Yoga</p>	<p align="center">6</p> <p>6:00 PM Yoga</p>	<p align="center">7</p>	<p align="center">8</p>
<p align="center">9</p> <p>8:00 AM HE Rite I 11:00 AM HE Rite II <i>Second Sunday of Advent</i></p>	<p align="center">10</p>	<p align="center">11</p> <p>7:00 AM Women's Prayer Breakfast @ Carolina Cafe 5:30 PM Handchimes 6:30 PM Adult Choir</p>	<p align="center">12</p> <p>7:00 AM Morning Prayer 10:00 AM HE Healing Service 6:00 PM Yoga 7:00 PM Brotherhood of St. Andrew Prison Meeting</p>	<p align="center">13</p> <p>6:00 PM Yoga</p>	<p align="center">14</p> <p><i>January 2008 Newsletter Articles Due</i></p>	<p align="center">15</p> <p>6:00 PM Angel Tree Party</p>
<p align="center">16</p> <p>8:00 AM HE Rite I 11:00 AM HE Rite II 12:30 PM Christian Ed Comm 12:30 PM Coffee Hour 12:30 PM Christmas Caroling 6:00 PM Vestry/Staff Party-ANNUAL REPORTS DUE <i>Third Sunday of Advent</i></p>	<p align="center">17</p> <p>5:30 PM Girl Scouts 6:00 PM NAMI</p>	<p align="center">18</p> <p>7:00 AM Women's Prayer Breakfast @ Carolina Cafe 5:30 PM Handchimes 6:30 PM Adult Choir</p>	<p align="center">19</p> <p>7:00 AM Morning Prayer 10:00 AM HE Healing Service 6:00 PM Yoga</p>	<p align="center">20</p> <p>6:00 PM Dayschool Program/Open House 6:30 PM Girl Scouts</p>	<p align="center">21</p>	<p align="center">22</p>
<p align="center">23</p> <p>8:00 AM HE Rite I 11:00 AM HE Rite II <i>Fourth Sunday of Advent</i></p>	<p align="center">24</p> <p>5:30 PM Christmas Eve Service 10:30 PM Midnight Service Office Closed</p>	<p align="center">25</p> <p>10:00 AM Christmas Day Service Office Closed</p> <p align="center">Christmas</p>	<p align="center">26</p> <p align="center">Office Closed</p>	<p align="center">27</p> <p>6:30 PM Brotherhood of St. Andrew Dinner Mtg. at Spindale Rest.</p>	<p align="center">28</p>	<p align="center">29</p>
<p align="center">30</p> <p>8:00 AM HE Rite I 9:00 AM Junior DOK 11:00 AM HE Rite II</p>	<p align="center">31</p> <p>Office Closed 11:30 pm New Year's Eve Service/Reception at Rectory</p>					

WORSHIP VOLUNTEERS FOR DECEMBER

8:00	2-Dec	9-Dec	16-Dec	23-Dec	30-Dec
Usher	Jane Cassada	Robert Wall	Richard Williams	Mary Gregory	William McClain
Usher	Dick Wilkins	Mary Ann Hamilton	Denise Hempstead	James Brown	Doug Price
Greeter	James Brown	Jane Cassada	Keppie D'Alessio	Sue Lloyd	Denise Hempstead
Reader	Josef Sibley	Denise Hempstead	Richard Williams	Linda Bailey	James Brown
Chalicer	Denise Hempstead	Nancy Bole	David D'Alessio	Cynthia Ruppe	Josef Sibley
Sunday School Greeter	Diane Dickerson	Magi King	Anita Quinley	Judy Scott	Kimberly Lloyd
11:00					
Usher	Gordon Scott	Vera Scroggs	Vernon Hoyle	Paul McIntosh	Eric Truempy
Usher	Judy Scott	Bill Coxe	Sam Ayers	Linda Jeanne Harrill	Betty Dickey
Greeter	Roger Hughes	Beverly McKinney	Judy Scott	Vera Scroggs	Art Tucker
Oblationer	Don Corry		Vera Scroggs	Rebecca Melton	Bob Blanton
Oblationer	Lyn Corry		Betty Dickey	Anita Quinley	Becky Reger
Yokefellow	Bud Quinley	Bud Quinley	Bud Quinley	Bud Quinley	Bud Quinley
1st Reader	Ed Richardson	Linda Jeanne Harrill	Miriam Dixon	Barbara Hobson	Vernon Hoyle
2nd Reader	Nancy Bole	Rebecca Melton	Ed Richardson	Susanne Richardson	Becky Reger
Prayers	Judi Gustafson	Roger Hughes	Susan Keith	Miriam Dixon	Bill Coxe
Chalicer	Ed Richardson	Bob Blanton	Mary Brown	Gerry Roberts	Don Corry
Nursery	Sherry Campbell	Linda Bailey	Anita Quinley	Denise Hempstead	Keely McBrayer
	Kimberly Lloyd	Magi King	Sue Lloyd	Beverly McKinney	Michelle Riberdy
Acolytes	Team 1	Team 2	Team 1	Team 2	Susan Keith
					Rebecca Melton
					Beverly McKinney
					Denise Hempstead
					Miriam Dixon
Coffee Hour 8	Vicki Dury				
Coffee Hour 11			Jesse McKinney		
			Beverly McKinney		
Potluck	Linda Bailey				
	Bill Coxe				
	Susan Keith				

IF YOU CANNOT SERVE, PLEASE FIND A REPLACEMENT
AND **THEN** CALL THE CHURCH OFFICE. 828-287-3888



The Windows of St. Francis Episcopal Church 2008 Calendar

\$15.00

*Profits from the sale of this calendar will
help establish a Restoration Fund for the
upkeep of our 108 year old church building!*

January 2008

Sun	Mon	Tue	Wed	Thu	Fri	Sat
		1	2	3	4	5
6	7	8	9	10	11	12
13	14	15	16	17	18	19
20	21	22	23	24	25	26
27	28	29	30	31		

Happy New Year ♪ *Happy New Year* ♪ *Happy New Year*

**Celebrate the New Year
at
St. Francis**

11:30 pm
December 31, 2007

*Reception following service
at the Rectory!*



Happy New Year ♪ *Happy New Year* ♪ *Happy New Year*

VESTRY NOMINATIONS

Josephine Conn

I was born and raised in Rutherfordton. I lived and worked in New York City for eleven years. I am married to Roscoe Conn, Sr. and we have four children and seven grandchildren. I have been attending St. Francis Episcopal Church since September 15, 1998 and was confirmed on April 18, 1999. I am a choir member, and also a member of the altar guild. I have hosted pot luck, coffee hour and punch on the lawn. I have served on the church council at my previous church and also on the North Carolina Synod Council of The Evangelical Lutheran Church. I would consider it a privilege to serve on the Vestry of St. Francis if elected.

Susan Keith

I am a cradle Episcopalian and have attended the Episcopal Church most of my life. I moved to St. Francis from Virginia in 2002. I was very blessed to be warmly welcomed into the family of St. Francis. I served as Parish Administrator for a couple of years and have been active in the Episcopal Church Women. I currently assist in the beauty of our worship in a variety of ways including being a lector, adult acolyte and chalice bearer. I am also blessed to be very involved in the activities of the Daughters of the King including guiding our young ladies in the Junior Daughters of the King. I help in the process of recording our services so that they can be shared with our shut-ins. I actively support our Relay For Life team and am enrolled in the Education For Ministry program.

I am currently serving the Diocese of Western North Carolina as a trainer for Safeguarding God's Children and as Diocesan Directress for the Junior Daughters of the King.

I have been married for 20 years to John and have three children, Sunshine (golden retriever), Miss Amy (mini poodle) and Jaxom (cat).

I love the people of St. Francis and would be blessed to serve this family in any capacity to which I am called.

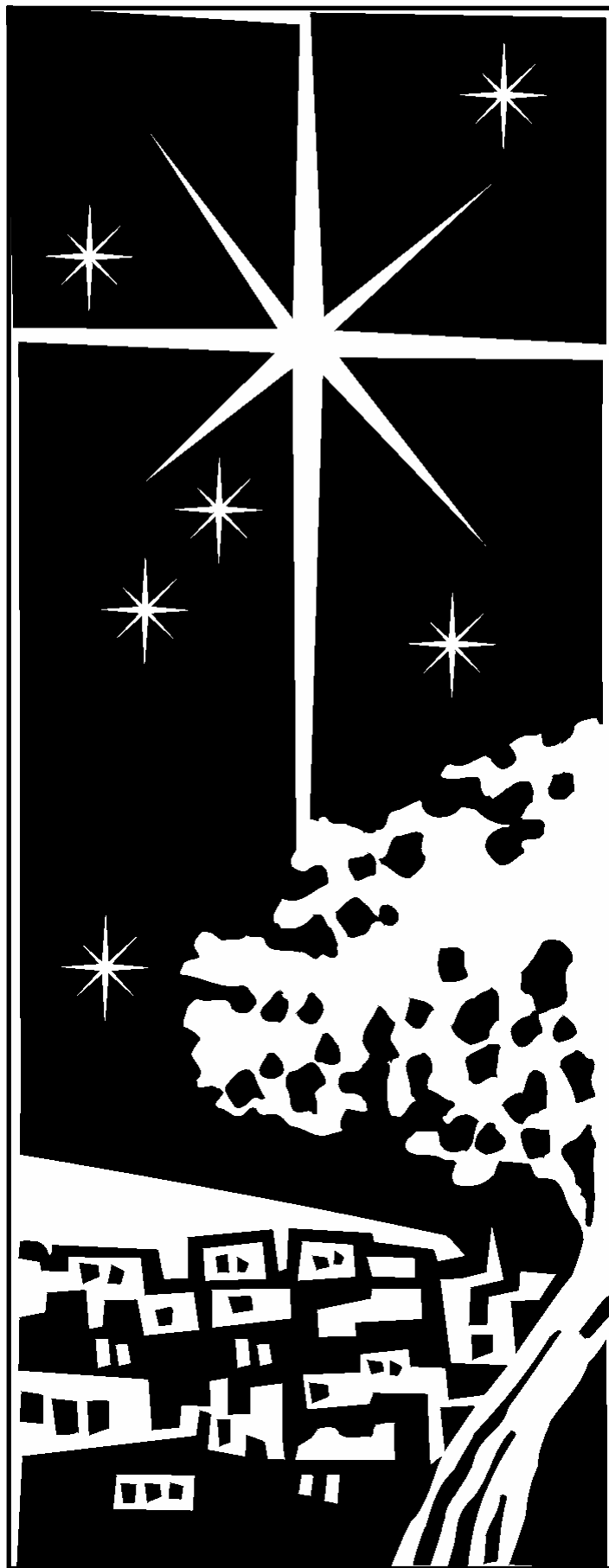

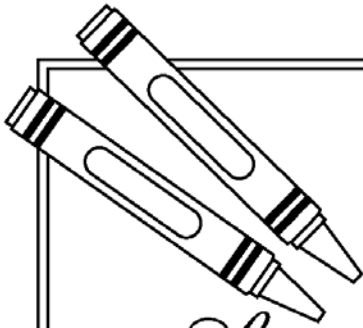

Just for **KIDS**

The Son of the Highest

A new baby brings joy and the anticipation of what he or she will grow up to become. Jesus' birth was miraculous, but His life was prophesied and planned by God.

Unscramble the words below, matching them to their correct spelling. Then use the numbers to fill in the correct words to complete Luke 1:32-33 (NIV).

- | | | | |
|-----------|--------|------------|---------|
| 12. taerg | he | 2. noS | forever |
| 8. eh | Jacob | 11. seouh | end |
| 13. gHhi | father | 5. northe | Son |
| 7. aDvid | give | 1. roevefr | house |
| 10. bocJa | great | 6. dingmok | throne |
| 3. reafth | High | 9. den | kingdom |
| 4. vieg | David | | |

"He will be _____₁₂ and will be called the _____₂
of the Most _____₁₃. The Lord God will _____₄
him the _____₅ of his _____₃ _____₇,
and _____₈ will reign over the _____₁₁
of _____₁₀ _____₁; his _____₆ will
never _____₉."

Luke 1:32-33, NIV

PAPER BAG LUMINARIAS

Lead your family and friends to your house this holiday with luminarias celebrating Jesus' birth.

WHAT YOU NEED:

- Pencil
- Brown paper lunch bags
- Hole punch, tack or pushpin
- Sand
- Votive candles or tea lights

WHAT YOU DO:

- 1 Draw a simple picture, word or symbol of Jesus' birth on the bag; for example, a star, a manger, a heart, a lamb, a wise man or the word "JOY."
- 2 Using a hole punch or pushpin, punch holes along the drawing, leaving a little space between each hole. Punch all the way through both sides of the bag so you end up with the same design on both sides when the bag is opened. When using a pin, place a piece of cardboard under the bag or work on carpet so nothing gets damaged.
- 3 Open the bag and fill each luminaria with about two inches of sand. Then sink a votive candle or tea light in the center of the sand.
- 4 Place the luminarias along a walk, patio or porch. Have an adult light the candles.

Answers: 1. forever 2. Son 3. father 4. give 5. throne 6. kingdom 7. David 8. he 9. end 10. Jacob 11. house 12. great 13. High

DECEMBER BIRTHDAYS

DECEMBER ANNIVERSARIES

3 Haden Noyes
 5 Meagan Hunt
 8 Jacqueline Lemon
 10 Isaac King
 11 Charles Langdon
 13 Jane Bell
 13 Gillian Pickard
 14 Carletta Pittman
 17 Vernon Hoyle
 18 Sarah Earley
 19 Missy Hughes

21 Paul Riexinger
 22 Ashley Carpenter
 22 Ryan Crummie
 22 Devon McRorie
 23 Jacqueline McEntire
 27 William McClain
 28 Martha Fairer
 28 Michelle Riberdy
 29 Anita Quinley
 29 Ann Thompson

7 Jeff & Keely Edwards-McBrayer
 20 Vernon & Caroline Hoyle
 21 Mr. & Mrs. Eric Truempy
 24 Thomas & Sarah Strand
 26 Scott & Elaine Sprouse
 27 Dick & Martha Wilkins
 30 Alex & Jane Bell



CHRISTMAS POINSETTIAS FOR THE CHURCH



Poinsettias

Each year, we accept gifts of poinsettias which are used to decorate the church for Christmas. If you would like to give a gift, please fill out the form and drop your order in the mail or in the alms basin. The

name(s) of the person(s) you are honoring will be printed in the Christmas Eve bulletins.

Please return the form and money to the church office or place in the alms basin by **Sunday, December 16**. If you pay by check, please designate it for "Flowers."

I would like to order _____ Poinsettias @ \$15 each

Attached/Enclosed is my check/cash for \$ _____

In Memory of: _____

In Honor of: _____

In Thanksgiving for: _____

Given by: _____

Hear Our Prayer



WE REMEMBER IN PRAYER:

Albert,
Ayden,
Andy Barnes,
Reba Beasley,
Wanda Byers,
Michael Carrier,
Charles,
Charlie,
Clark ,
Rose Lee Crutcher,
Betty Elliott,
Carolyn Gardner,
Ernestine Gold,
Dorothy Goodrich,
Katie Graham,
Ron Haines,
David Hallock,

Hannah,
Ron Hobson,
Cathy Iadovito,
Jahnnie,
Jayne,
Joseph,
Justin,
George Lancaster,
Elizabeth Laughter,
Laura,
Pete Lee,
Franklyn McIntosh,
Olive Mistretta,
Betty Morehead,
Richard Morgan,
Arabella Philbeck,
Beth Philbeck,

Jason Philbeck,
Haley Riney,
Anita Russell,
Julie Scherer,
Kenneth Scroggs,
Stevie Scroggs,
Kay Taylor,
Nancy Tucker,
Linda Venderly,
Jack Warmath,
Sarah Warmath,
Keith Wellborn,
Keri Wellborn,
Hilda Wilson,
Everett Yelton,
Leonard Yelton

And Those Serving in the Military...

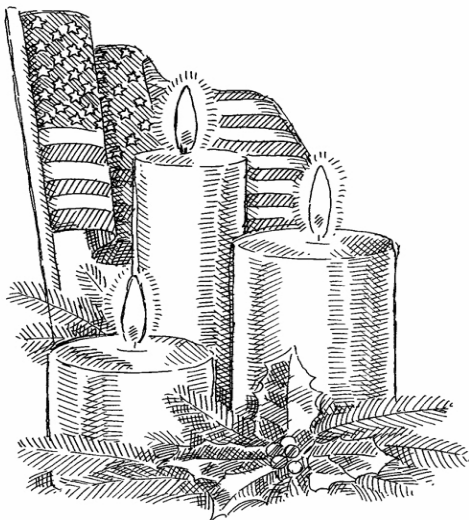

Ben Blanton,
Jim Boyette,
Cory Bridges,
J. D. Brock,
Forest Buff,
Scotty Clark,
Blake Craft,
Kyle Eller,
Andy Feree,
Branson Garrett,
Jason Hill,
Patsy Howard,
Robby Howard,

Natahley Infante,
Jason Kallaus,
Seth Keller,
Baxter Keys,
Andrew Kinard,
Tony Laws,
Troy Laws,
Daniel Leech,
Joseph McComas,
Drew Melvin,
Alaina Parker,
Michael Parker,
Nina Paulino,

Eric Neely,
Kenneth Queen,
Rory Semelroth,
Chris Sikes,
David Smith,
Jerome Smith,
Emmanuel Spencer,
Christopher Strand,
Kenneth Young

“Pray at all times in the Spirit, with all prayer and supplication. To that end keep alert with all perseverance, making supplication for all the saints...” Ephesians 6:18

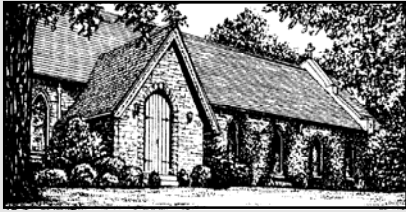

Through The Back Gate

A Monthly
Newsletter of
St. Francis Episcopal Church

The Episcopal Church of Rutherfordton
Established 1842

408 North Main Street
P. O. Box 46
Rutherfordton, NC 28139

Church Office: 287-3888

Service Times: Extension 1

Rector: Extension 2

Dayschool/Kitchen: Extension 3

Parish Administrator: Ext. 4

Music Director: Extension 5

Fax: 287-4849

E-mail: stfrancis@rfci.net

www.stfranchischurch.org

<i>Jesus Christ</i>	The Head
<i>The People of God</i>	The Ministers
<i>The Right Reverend G. Porter Taylor</i>	Bishop
<i>The Reverend Dee Ann de Montmollin</i>	Rector
<i>Johnathan Jones</i>	Minister of Music
<i>Amberleigh Richardson</i>	Youth Director
<i>Lesley Bush</i>	Parish Administrator
<i>Cindy Hill</i>	Financial Manager

The Vestry

Paul McIntosh, Senior Warden

Don Corry, Junior Warden

Rob Bole, Treasurer

2007

Roscoe Conn, Sr.

Paul McIntosh

Dick Wilkins

2008

Marian Beavers

Don Corry

Nancy Tucker

2009

Linda Bailey

Ed Richardson

James Segers

The Vestry meets the second Monday of every month.

Our Missionaries:

Jim & Jennifer Bowers - Mali

- China

John and Zophi Wilson - Hungary

Amber Smith - Poland

Russ & Heidi Smith - Chili

Lynn Coulthard - Durgapur

Non-Profit
Organization
U.S. Postage Paid
Rutherfordton, NC
28139
Permit No. 75

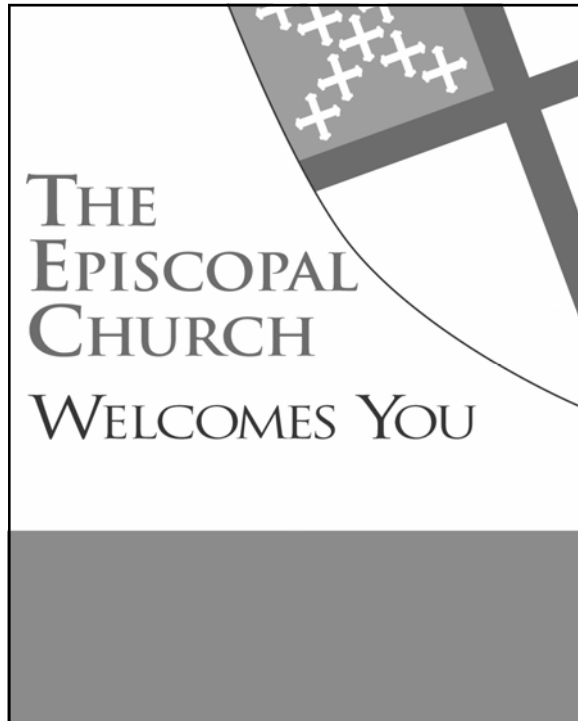

The purpose of St. Francis Episcopal Church is to function as a Christian family in which all are nurtured in Jesus Christ through Scripture, sacrament, prayer, and love, enabling us to proclaim God's love joyfully and witness to His power.